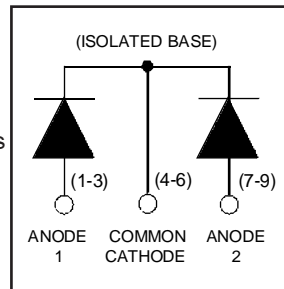


# HFA75MB40C

Ultrafast, Soft Recovery Diode

## Features

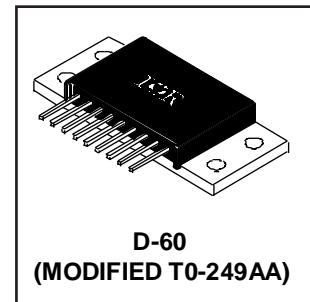
- Reduced RFI and EMI
- Reduced Snubbing
- Extensive Characterization of Recovery Parameters



$V_R = 400V$
$V_F(\text{typ.})^{\text{Ⓢ}} = 1V$
$I_{F(AV)} = 75A$
$Q_{rr}(\text{typ.}) = 200nC$
$I_{RRM}(\text{typ.}) = 6A$
$t_{rr}(\text{typ.}) = 30ns$
$di_{(rec)M}/dt(\text{typ.})^{\text{Ⓢ}} = 190A/\mu s$

## Description

HEXFRED™ diodes are optimized to reduce losses and EMI/RFI in high frequency power conditioning systems. An extensive characterization of the recovery behavior for different values of current, temperature and di/dt simplifies the calculations of losses in the operating conditions. The softness of the recovery eliminates the need for a snubber in most applications. These devices are ideally suited for power converters, motors drives and other applications where switching losses are significant portion of the total losses.



## Absolute Maximum Ratings (per Leg)

	Parameter	Max.	Units
$V_R$	Cathode-to-Anode Voltage	400	V
$I_F @ T_C = 25^\circ C$	Continuous Forward Current	75	A
$I_F @ T_C = 100^\circ C$	Continuous Forward Current	36	
$I_{FSM}$	Single Pulse Forward Current ①	300	
$I_{AS}$	Maximum Single Pulse Avalanche Current ②	5.0	mJ
$E_{AS}$	Non-Repetitive Avalanche Energy ②	1.4	
$P_D @ T_C = 25^\circ C$	Maximum Power Dissipation	125	W
$P_D @ T_C = 100^\circ C$	Maximum Power Dissipation	50	
$T_J$	Operating Junction and	-55 to +150	°C
$T_{STG}$	Storage Temperature Range		
	Soldering Temperature, for 10 sec.	300 (0.063 in. (1.6mm) from case)	

## Thermal - Mechanical Characteristics

	Parameter	Min.	Typ.	Max.	Units
$R_{\theta JC}$	Junction-to-Case, Single Leg Conducting	----	----	1.0	°C/W K/W
	Junction-to-Case, Both Legs Conducting	----	----	0.50	
$R_{\theta CS}$	Case-to-Sink, Flat, Greased Surface	----	0.10	----	
$Wt$	Weight	----	58 (2.0)	----	g (oz)
	Mounting Torque	35 (4.0)	----	50 (5.7)	lbf·in (N·m)

**Note:** ① Limited by junction temperature  
 ② L = 100μH, duty cycle limited by max  $T_J$   
 ③ 125°C

# HFA75MB40C

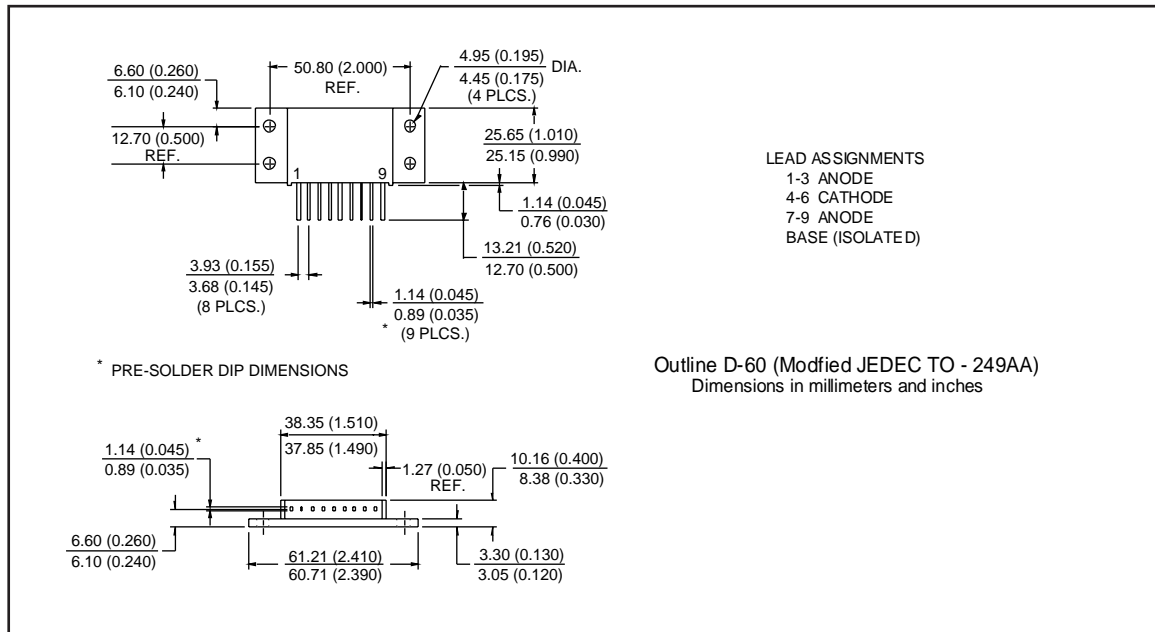
International  
**IOR** Rectifier

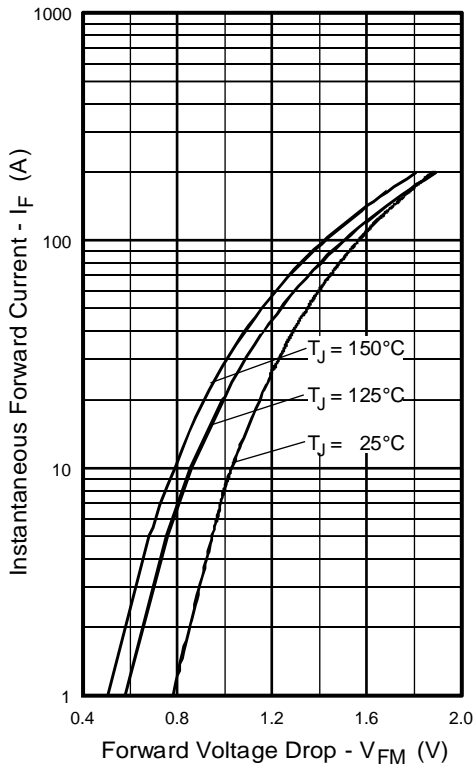
## Electrical Characteristics (per Leg) @ $T_J = 25^\circ\text{C}$ (unless otherwise specified)

	Parameter	Min.	Typ.	Max.	Units	Test Conditions
$V_{BR}$	Cathode Anode Breakdown Voltage	400	—	—	V	$I_R = 100\mu\text{A}$
$V_{FM}$	Max Forward Voltage	—	1.1	1.3	V	$I_F = 35\text{A}$
		—	1.3	1.5		$I_F = 75\text{A}$
		—	1.0	1.2		$I_F = 35\text{A}, T_J = 125^\circ\text{C}$
$I_{RM}$	Max Reverse Leakage Current	—	0.50	3.0	$\mu\text{A}$	$V_R = V_R$ Rated
		—	0.75	4.0	$\text{mA}$	$T_J = 125^\circ\text{C}, V_R = 320\text{V}$
$C_T$	Junction Capacitance	—	90	125	$\text{pF}$	$V_R = 200\text{V}$
$L_S$	Series Inductance	—	9.2	—	$\text{nH}$	Lead to lead 5mm from package body

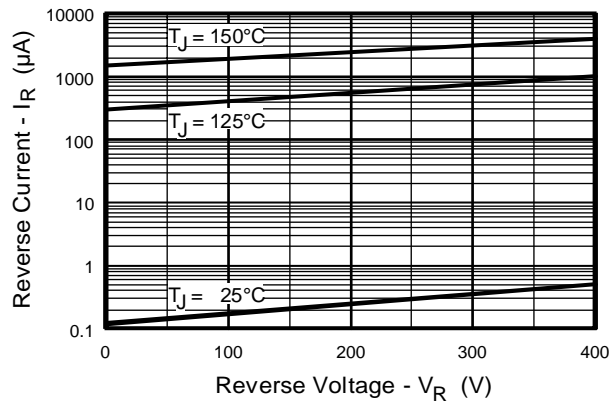
## Dynamic Recovery Characteristics (per Leg) @ $T_J = 25^\circ\text{C}$ (unless otherwise specified)

	Parameter	Min.	Typ.	Max.	Units	Test Conditions
$t_{rr}$	Reverse Recovery Time	—	30	—	ns	$I_F = 1.0\text{A}, di/dt = 200\text{A}/\mu\text{s}, V_R = 30\text{V}$
$t_{rr1}$		—	67	100		$T_J = 25^\circ\text{C}$ See Fig.
$t_{rr2}$		—	110	170		$T_J = 125^\circ\text{C}$ 5
$I_{RRM1}$	Peak Recovery Current	—	6.0	11	A	$T_J = 25^\circ\text{C}$ See Fig.
$I_{RRM2}$		—	9.0	16		$T_J = 125^\circ\text{C}$ 6
$Q_{rr1}$	Reverse Recovery Charge	—	200	540	nC	$T_J = 25^\circ\text{C}$ See Fig.
$Q_{rr2}$		—	500	1300		$T_J = 125^\circ\text{C}$ 7
$di_{(rec)M}/dt1$	Peak Rate of Fall of Recovery Current	—	240	—	$\text{A}/\mu\text{s}$	$T_J = 25^\circ\text{C}$ See Fig.
$di_{(rec)M}/dt2$		During $t_b$	—	190		—

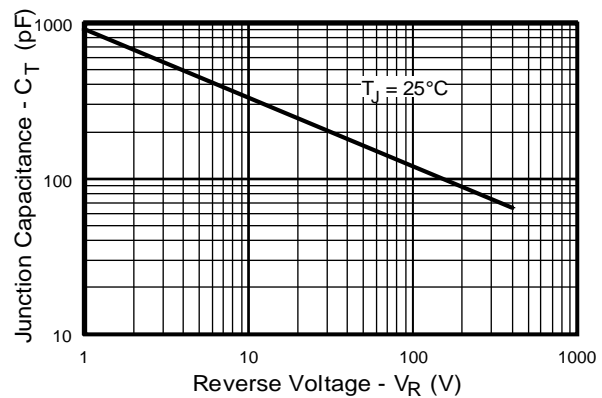




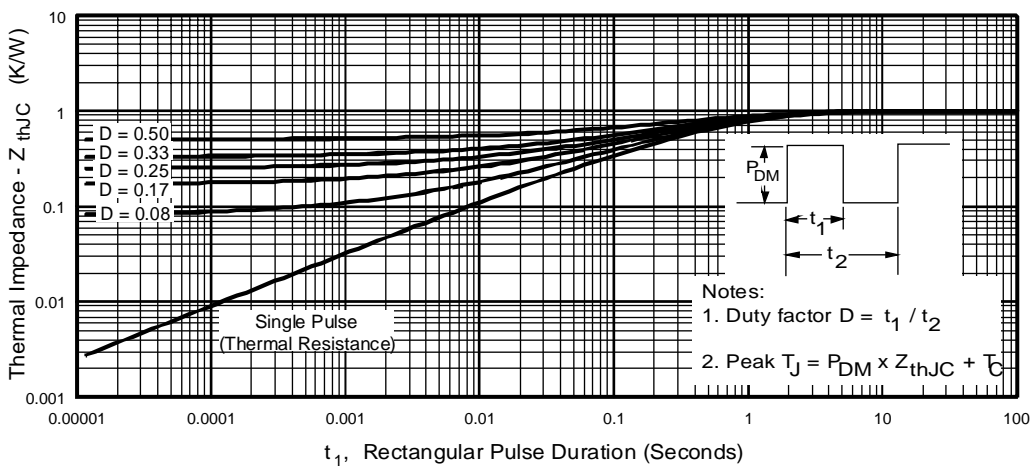
**Fig. 1** - Maximum Forward Voltage Drop vs. Instantaneous Forward Current, (per Leg)



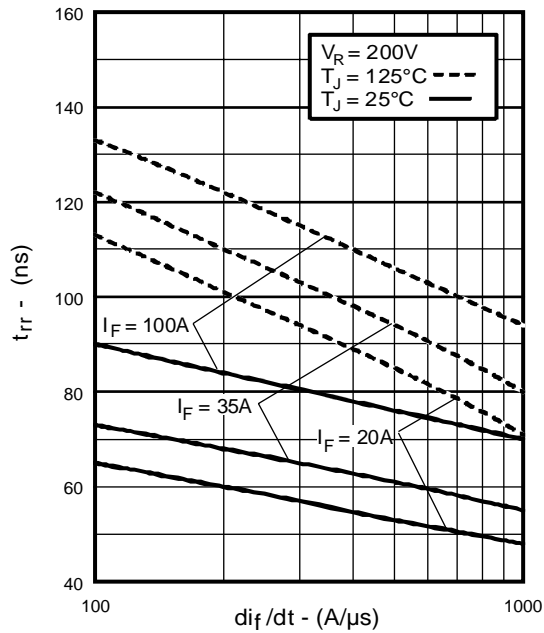
**Fig. 2** - Typical Reverse Current vs. Reverse Voltage, (per Leg)



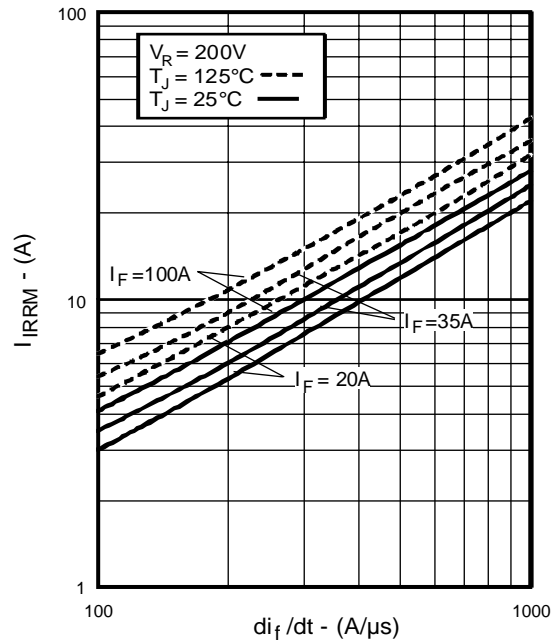
**Fig. 3** - Typical Junction Capacitance vs. Reverse Voltage, (per Leg)



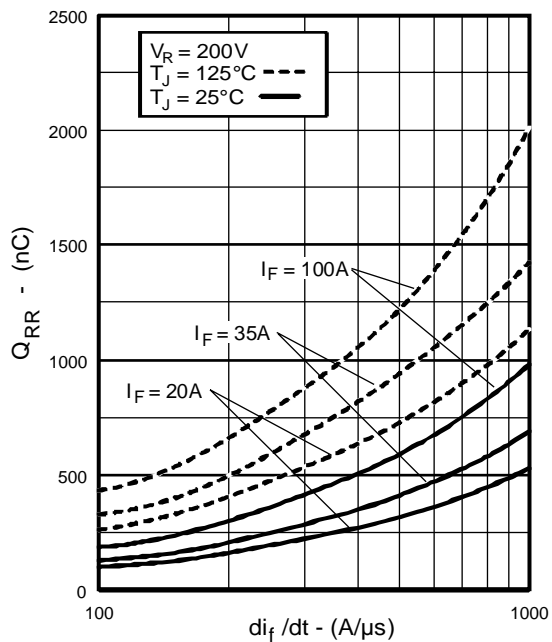
**Fig. 4** - Maximum Thermal Impedance  $Z_{thJC}$  Characteristics, (per Leg)



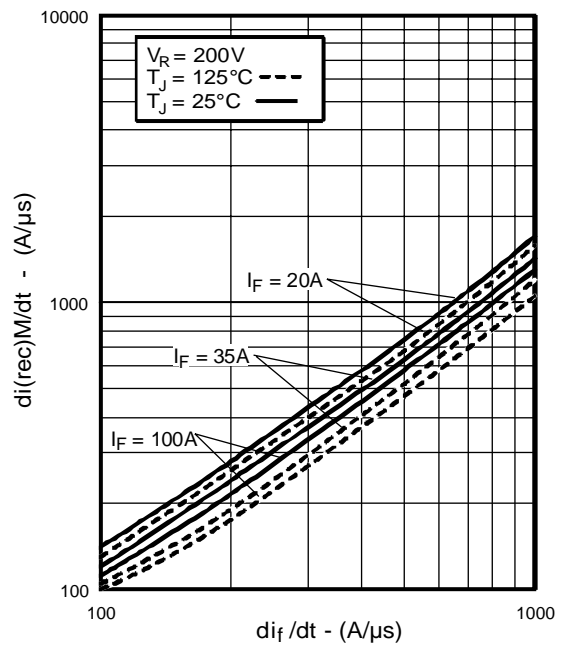
**Fig. 5 - Typical Reverse Recovery vs.  $di_f/dt$ , (per Leg)**



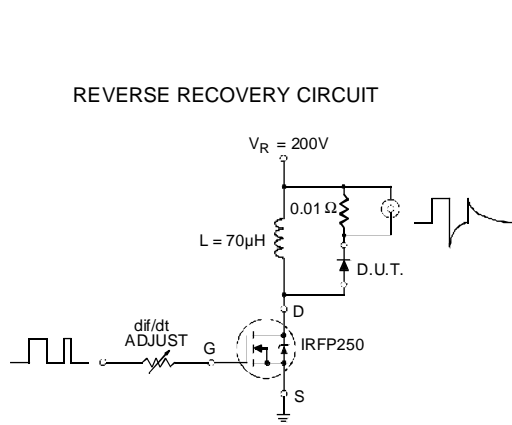
**Fig. 6 - Typical Recovery Current vs.  $di_f/dt$ , (per Leg)**



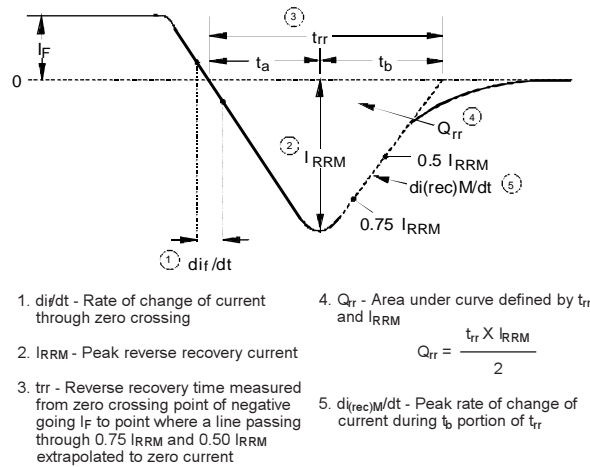
**Fig. 7 - Typical Stored Charge vs.  $di_f/dt$ , (per Leg)**



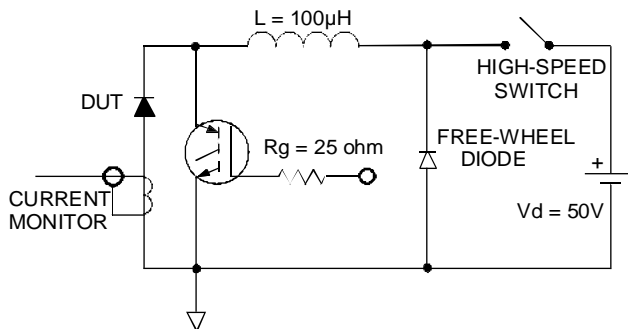
**Fig. 8 - Typical  $di_{(rec)M}/dt$  vs.  $di_f/dt$ , (per Leg)**



**Fig. 9 - Reverse Recovery Parameter Test Circuit**



**Fig. 10 - Reverse Recovery Waveform and Definitions**



**Fig. 11 - Avalanche Test Circuit and Waveforms**